



# Residential Patio Cover Specifications

This information bulletin describes the minimum requirements for obtaining patio cover permits for residential buildings using the City of Vista standard plan or ICC approved plans.

## Definition

1. Patio covers are one-story structures not more than 12 feet above grade and used only for recreational, outdoor living purposes
2. Patio covers may be attached or detached and are permitted only as accessory to one or two family dwellings or lodging houses or to individual dwelling units in multiple dwelling-unit buildings. Patio covers cannot be used as carports, garages, habitable rooms or storage structures.
  - a. Enclosure walls must have a clear height of not less than 6'-8" measured from the floor to the soffit of the supporting members.
  - b. Enclosure walls may have any configuration, provided at least 65 percent of the total wall area of the longer wall and one additional wall is open. Note that the sliding glass doors may not be included in the required open area. The openings must not be covered with any permanent materials which obstruct the free passage of light and air except insect screening having mesh not finer than 1/16" by 1/16", or readily removable transparent or translucent plastic of not more than 1/8" (0.125 inch) maximum thickness.

## Obtaining a Patio Cover Permit

Patio cover permits may be obtained "over-the-counter" when using the City of Vista standard plan or ICC approved plans. Plans not meeting the criteria for over-the-counter plan check must be submitted for plan review.

## Drawings to provide and forms to complete

Plans must be drawn to scale and must be of sufficient clarity to indicate the location, nature, and extent of the work proposed. Be sure to clearly label all existing and proposed construction.

Plans must show in detail that the proposed work will conform to the provisions of the California Building Code, Zoning Ordinances, and all other relevant laws, ordinances, rules, and regulations. Zoning information is available at the Development Services Center.

Three sets of plans are required and must include the following:

1. Plot Plan--See Figure 5 for requirements.
2. Foundation and Framing Plans--Provide one of the following:
  - a. One copy of the City of Vista standard plan (specifications in this information bulletin) with the proposed footing sizes, rafter sizes, and beam sizes highlighted; or,
  - b. One copy of an approved plan available from your material supplier and approved by a third party testing agency approved by the City of Vista.

- c. Three copies of any other plan. These plans should include a roof framing plan, foundation plan, elevations, cross-sections, and connection details.
3. Floor Plan—For patio covers within 6'-0" of a dwelling, include a floor plan and show the following information:
  - a. Use and dimensions of all rooms adjacent to the patio cover.
  - b. Size and type of all windows and doors from those rooms.
4. Permit Application—All projects must be submitted with a Permit Application. If you intend to obtain your permit on the same day as plan review, the application must be fully completed. Note: there are no exceptions to the Worker's Compensation Insurance requirements. If the property owner is doing the construction work or is hiring a number of different contractors, a separate Owner-Builder Verification form must be signed by the owner before the permit can be issued.

#### **Additional Regulations**

1. When openings required for light and/or ventilation within the dwelling unit itself open into a patio structure, the minimum ceiling height of the patio structure is 7'-0" measured from the floor surface to the underside of the rafters. When no required openings exist in the common wall, the minimum required height for the patio cover is 6'-8". See California Building Code Section 1205.2, Exception.
2. All electrical wiring and equipment must comply with regulations for exterior installation.

#### **Construction Specifications**

The following are the minimum construction specifications for patio covers.

1. The concrete mix for footings must meet a compressive strength of  $f'_c=2,500$  psi minimum.
2. Lumber must be Douglas fir-larch No. 2 or better. All lumber must be grade-marked. Joists, girders, and posts may be required to be protected against decay and termites. All posts must be a minimum of 4x4.
3. The post anchorage and bracing details shown on the following sheets have been approved by the City of Vista for un-enclosed patio covers.
  - a. Posts must be anchored at the lower end and must be braced at the upper end using any of the details shown in Figure 2. Decorative-type bracing may be substituted if the same resistance to lateral loading is provided.
  - b. Post anchorage to slabs may be accomplished with a standard approved post base installed per manufacturer's instructions. The footing must be adequate for the applied load. See Table A for footing size requirements. When the load on supporting post does not exceed 750 pounds per post, a minimum 3 ½-inch-thick concrete slab-on-grade may be substituted for the pad footings shown on the typical framing details.
4. When it is desired to connect and support one side of the patio structure by attaching it directly to the house, the rafter spacing and beam sizes may be as shown in Tables B and C. However, the main beam may be replaced on the side attached to the dwelling unit with a ledger the same size as the rafters and fastened to the studs with ½"x5" lag screws spaced

at 32" maximum on center for up to a 10'-0" rafter span. Lag screws may be spaced at 16" maximum on center when the rafter span is greater than 10' but does not exceed 20'-0".

(Attaching the rafters to existing dwelling unit rafters is not an approved detail). If a ledger beam is not used, patio cover rafters should be notched and placed directly on the double top plate of the dwelling unit.

5. Specify roof covering (shingles, shakes, etc.) when submitting plans. If nominal one-half-inch-thick roof sheathing is used, the roof may have rafters spaced not more than 24" on center. If plastic roof coverings are used, installation must be according to manufacturer's recommendations and the corrugations must be placed perpendicular to and across the supports. Roof systems shall be sloped  $\frac{1}{4}$  inch in 12 inches minimum for drainage.

### Inspections

An Inspection Record Card is issued at the time the permit is obtained. The inspector signs this card as the construction is inspected and approved. The approved plans, the Inspection Record Card, and the permit are important records and should be retained.

A combination permit is active for 180 days. Each inspection scheduled and passed extends the permit 180 days. Permits approaching expiration can be extended under special circumstances.

Inspections are required at the following times:

- When footings have been excavated but before concrete is placed,
- When ledger beams are attached to an existing structure, and
- When work is complete.

Note: The project is not legally complete until there is an approved final inspection. Call (760) 639-6106 to schedule inspections.

### Tables

Tables A, B, and C make the following assumptions:

Roof live load is 10 psf.

Roof Dead load is 7 psf.

All lumber is to be Douglas fir-larch No. 2 or better:

Fb=825 psi
Fv=90 psi
E=1,200,000 psi

Repetitive member use.

All posts are to be 4x4 minimum.

Soil bearing pressure is 1,000 psf minimum.

If the above information differs, values in the tables must be adjusted.

**Table A Minimum Square Footing Sizes (Inches)\***

Post Spacing (Feet)	Rafter Span (Feet)							
	6	8	10	12	14	16	18	20
4	12	12	12	12	12	12	12	12
6	12	12	12	12	12	12	12	14
8	12	12	12	12	12	14	14	14
10	12	12	12	14	14	14	16	16
12	12	12	14	14	16	16	18	18
14	12	12	14	16	16	18	18	20
16	12	14	14	16	18	18	20	20
18	12	14	16	18	18	20	20	22
20	14	14	16	18	20	20	22	24

\*See dimension "A" on "Figure 2, Case 4."

**Table B Rafter Spacing Center-to-Center (Inches)**

Rafter Span (Feet)	12 (5/16" plywood sheathing)	16 (3/8" plywood sheathing)	24 (1/2" plywood sheathing)	32 (5/8" plywood sheathing)
	6	2x4	2x4	2x4
7	2x4	2x4	2x4	2x4
8	2x4	2x4	2x6	2x6
9	2x4	2x6	2x6	2x6
10	2x6	2x6	2x6	2x6
11	2x6	2x6	2x6	2x6
12	2x6	2x6	2x6	2x8
13	2x6	2x6	2x8	2x8
14	2x6	2x6	2x8	2x8
15	2x6	2x8	2x8	2x10
16	2x8	2x8	2x8	2x10
17	2x8	2x8	2x10	2x10
18	2x8	2x8	2x10	2x10
19	2x8	2x10	2x10	2x12
20	2x8	2x10	2x10	2x12

**Table C**

Post Spacing (Feet)	Rafter Span (In Feet)								
	4	6	8	10	12	14	16	18	20
4	4x4	4x4	4x4	4x4	4x4	4x4	4x4	4x4	4x4
6	4x4	4x4	4x4	4x4	4x4	4x4	4x4	4x4	4x6
8	4x4	4x4	4x6	4x6	4x6	4x6	4x6	4x6	4x6
10	4x4	4x6	4x6	4x6	4x6	4x6	4x8	4x8	4x8
12	4x6	4x6	4x6	4x8	4x8	4x8 6x8	4x8 6x8	4x8 6x8	4x10 6x8
14	4x6	4x8	4x8	4x8 6x8	4x8 6x8	4x10 6x8	4x10 6x10	4x10 6x10	4x10 6x10
16	4x8	4x8 6x8	4x8 6x8	4x10 6x8	4x10 6x8	4x10 6x10	4x12 6x10	4x12 6x10	4x14 6x10
18	4x8	4x10 6x8	4x10 6x8	4x10 6x8	4x10 6x10	4x12 6x10	4x12 6x10	4x14 6x12	4x14 6x12
20	4x8 6x8	4x10 6x10	4x10 6x10	4x12 6x10	4x12 6x10	4x14 6x12	4x14 6x12	6x12	6x14

Figure 1/Typical Patio construction

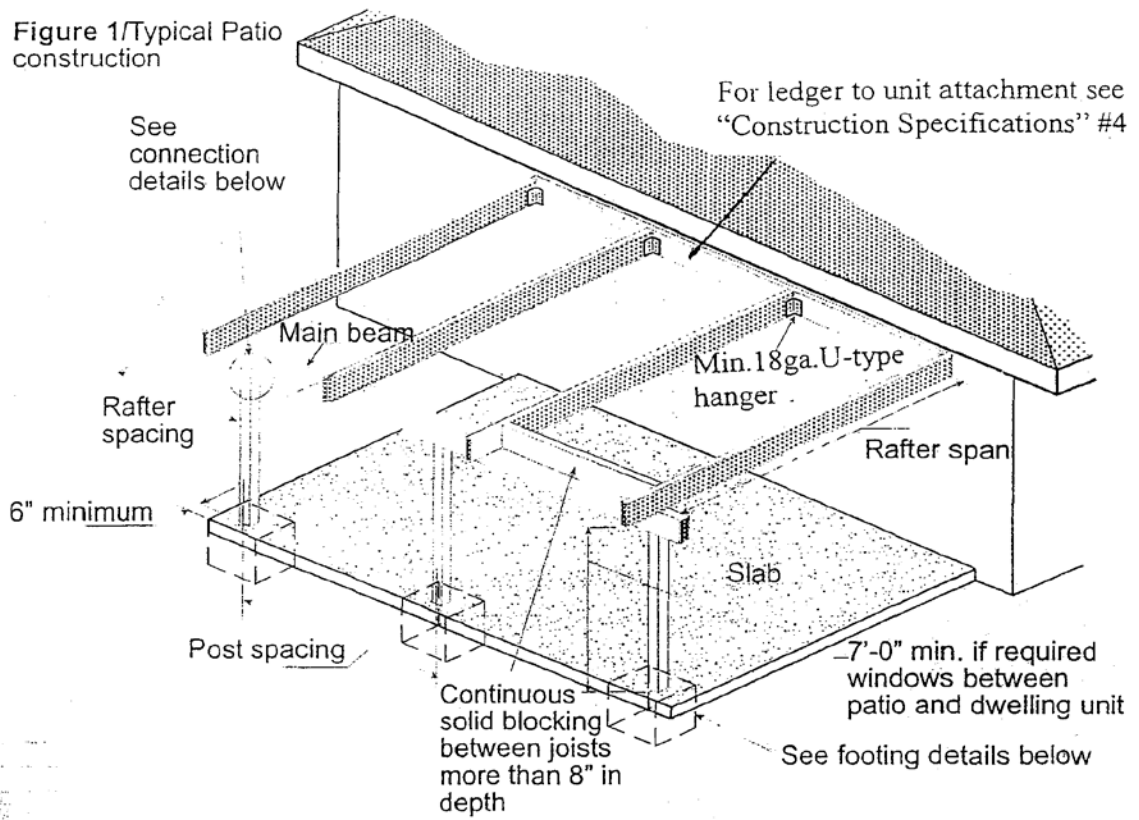
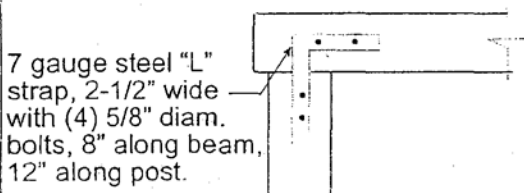
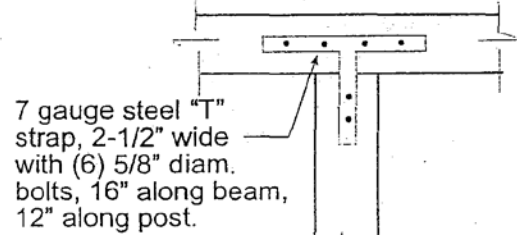

Figure 2/Connection, anchor and footing details

Case 1/Connection, end condition



Case 2/Connection, interior condition



Case 3/Anchor and footing detail slab

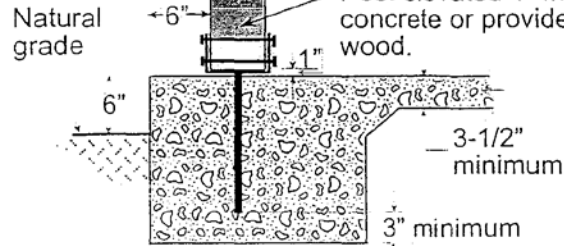

Case 4/Anchor and footing detail, isolated pier slab

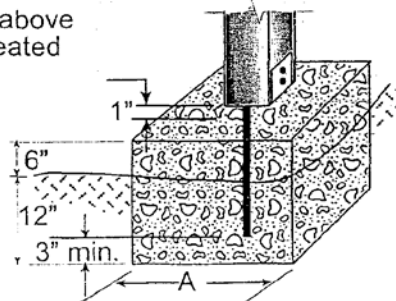

**Figure 3/Enclosed Patio Section**

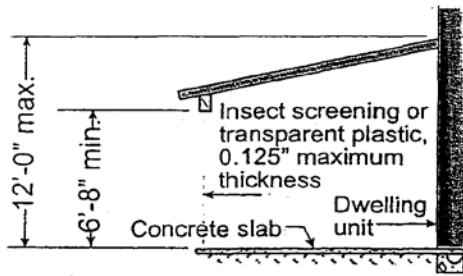

**Figure 4/Enclosed Patio Interior elevation**

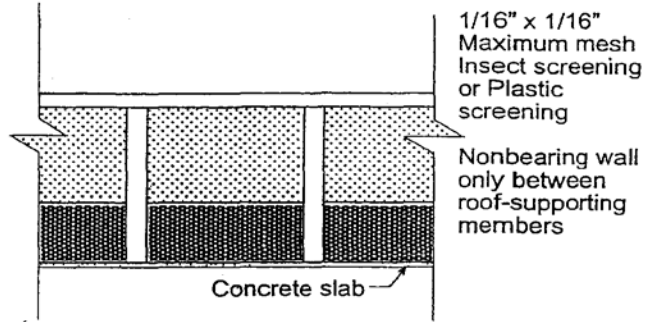

**Figure 5/Sample Patio Plot Plan**

Three copies of Plot Plan are required for a permit.

You must include information on each of the following items on the Plot Plan:

1. Name of Owner
2. Address and Assessor's Parcel Number where the patio is to be built.
3. Legal description of Property.
4. North arrow and scale. Suggested scale: 1 inch equals 20 feet.
5. Boundaries and dimensions of property.\*
6. Names of bordering streets.\*
7. Width of alley(s), if any.\*
8. Location and width of easements. Private easements should be shown on the property's deed.\*
9. Location and dimensions of existing buildings structures, retaining walls, paved parking and driveways. Include distance from curb to property line.
10. Location and dimensions of proposed patio. include distances to property lines.
11. Location and spacing of all posts supporting patio.
12. Existing survey hubs, pipes and similar permanently installed property line identification.

